

# DT701 SCOREBOARD WITH PERIOD AND POSSESSION ARROW INSTRUCTION MANUAL



**FEATURES:**

- 24-hour clock display
- Count up timer with range to 9 hr. 59min. 59sec.
- Countdown timer with loud beep
- Interval Countdown Timer
- Able to show the Set Points of two teams
- Display period number together with possession arrow
- Display scores of two teams up to maximum score of 199
- RF remote control – no cords required
- Large 4 inches LCD digits for viewing from as far away as 50M(150feet)
- Powered by AC adapter (included) or batteries (four D size – not included)
- Wall mounted or free standing
- 16 different RF channels, user-adjustable to another channel to avoid interference with nearby units

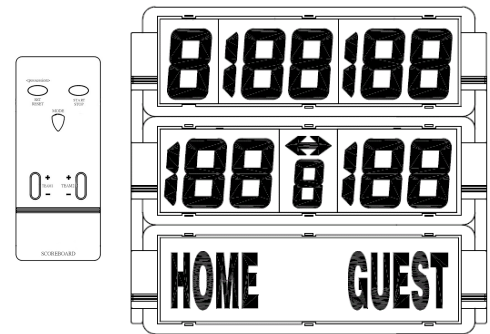

Figure 1

**LIST OF ACCESSORIES**

- Scoreboard
- Remote control with four AAA batteries
- Stands
- AC adapter (For indoor use only)
- Instruction manual

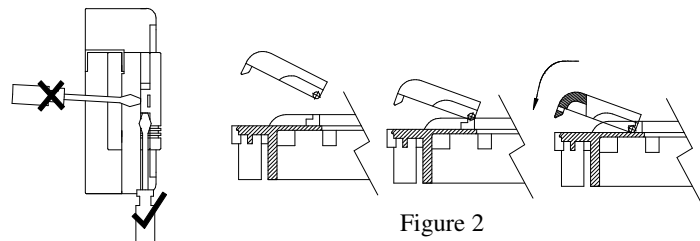

Figure 2

**HOW TO OPEN NAME PLATE DOORS**

Use a suitable screwdriver to open the side doors as shown in Figure 2. Do this carefully so as not to damage the plastic side doors. This allows the removal or insertion of the nameplates and advertisements.

**MOUNTING THE SCOREBOARD**

The Scoreboard can be mounted on the wall by the means of two screws hooked into the eyelets on the back of the top housing. Make sure the screws are securely fixed on the wall. The Scoreboard can also stand-alone on the floor or on a table using the stands of the Scoreboard as shown in Figure 3.

**POWER UP**

For AC connection, use only the AC adapter (9V) supplied with the unit. Verify the power rating indicated on the adapters is the same as the AC power supplied in your location. Plug the adapter into the socket on the right side of the Scoreboard as shown in Figure 3. The digits will light up automatically and be ready for setting.

When AC power is not available, insert four D size batteries into the battery compartment on the back of the Scoreboard as shown in Figure 4. When using battery power, the ON/OFF SWITCH can be used to turn the Scoreboard on and off. If the batteries are left in the Scoreboard during AC operation, they serve as a back up in the event of AC power interruption. The volume switch is used for tuning the volume to HIGH, LOW or OFF. The scoreboard remote control needs four 1.5V AAA size batteries to operate as shown in Figure 5.

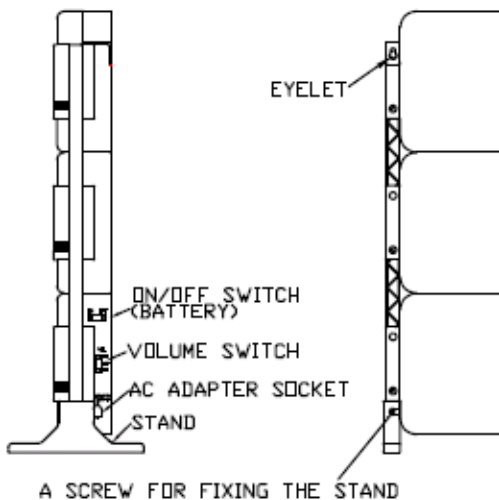

Figure 3

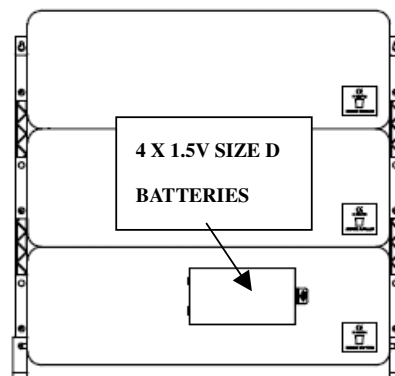

Figure 4

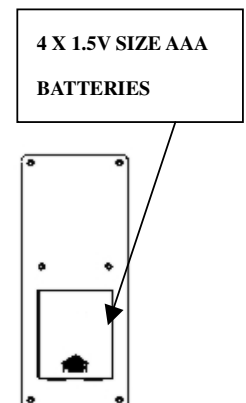

Figure 5

## TIME SETTING

- 1) In the TIME DISPLAY MODE shown in Figure 6, press and hold <MODE> for 3 seconds to enter the TIME SETTING MODE. “Hour” will be shown as in Figure 7.
- 2) Press <SET/POSSESSION> to enter the mode and the time digits will blink.
- 3) Adjust hour by pressing <+/-TEAM1> and adjust minute by pressing <+/-TEAM2>.
- 4) Press <SET/POSSESSION> when setting finishes.



Figure 6

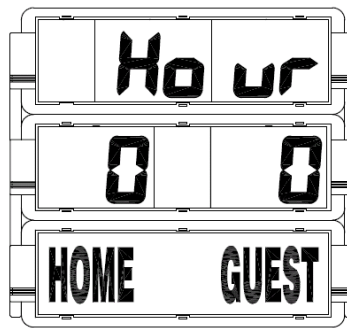

Figure 7

## COUNT UP MODE

- 1) In the TIME DISPLAY MODE, press and hold <MODE> for 3 seconds 2 times to enter the COUNT UP MODE. “C UP” is shown as in Figure 8.
- 2) Press <SET/POSSESSION> to enter. The timer will switch to 0:00:00 while the period and possession arrow will blink.
- 3) Press <+/-TEAM2> to adjust the period number which goes from 1>2>3>4>n>1>.....(where n implies that the period will keep blank.)
- 4) Press <+/-TEAM1> to enable or disable the possession arrow alternately.
- 5) Press <SET/POSSESSION> after setting the period and possession arrow.
- 6) Press <START/STOP> to start and stop the count up timer.
- 7) Press <SET/POSSESSION> to alter the arrow direction during the count up process.
- 8) When timer stops, press and hold <SET/POSSESSION> for 3 seconds to reset the timer to zero.
- 9) Under any static state, press and hold <MODE> for 3 seconds to enter the COUNT DOWN MODE.

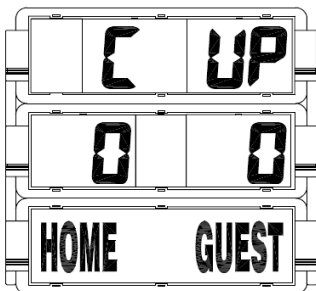

Figure 8

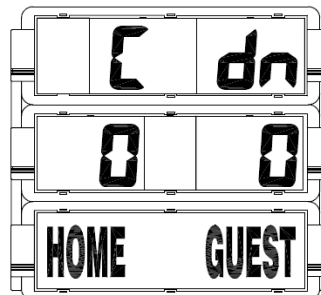

Figure 9

## COUNT DOWN MODE

- 1) In the TIME DISPLAY MODE, press and hold <MODE> 3 seconds 3 times to enter the COUNT DOWN MODE. “C dn” is shown as in Figure 9.
- 2) Press <SET/POSSESSION> to enter. The previous countdown time digits will blink.
- 3) Press <+/- TEAM 1> to adjust the minutes and hours. Press <+/- TEAM 2> to adjust the seconds.
- 4) Press <SET/POSSESSION> to confirm the timer setting, the count down time will be stored in the memory. The period and possession arrow will start blinking.
- 5) Press <+/-TEAM2> to adjust the period number as before.
- 6) Press <+/-TEAM1> to enable or disable the possession arrow alternately.
- 7) Press <SET/POSSESSION> after setting the period and possession arrow.
- 8) Press <START/STOP> to start and stop the count down timer.
- 9) Press <SET/POSSESSION> to alter the arrow direction during the count down process.
- 10) The scoreboard will give a long beep when the time is up.
- 11) When the count down timer stops, press and hold <SET/POSSESSION> for 3 seconds to reset the timer to the original memorized record.

- 12) When the count down timer stops, press <MODE> to adjust the timer that will blink momentarily. Press <+/- TEAM 1> and <+/- TEAM 2> to adjust the count down timer as before.
- 13) When the time is up, press and hold <SET/POSSESSION> for 3 seconds to reset the timer back to the memorized time.
- 14) Under any static state, press and hold <MODE> for 3 seconds to enter the INTERVAL COUNT DOWN MODE.

### INTERVAL COUNT DOWN MODE

- 1) In the TIME DISPLAY MODE, press and hold <MODE> 3 seconds 4 times to enter the INTERVAL COUNT DOWN MODE. "Int Cd" is shown as in Figure 10.
- 2) Press <SET/POSSESSION> to enter. The Interval Count Down timer "A" will blink as in Figure 11. The first digit on the top row shows the timer indicator.
- 3) Press <+/- TEAM 1> and <+/- TEAM 2> to adjust the timer "A".
- 4) Press <SET/POSSESSION> after setting timer "A", the display will turn to timer "B" automatically. The timer indicator will become "b" as in Figure 12.
- 5) Press <+/- TEAM 1> and <+/- TEAM 2> to adjust the timer "B".
- 6) Press <SET/POSSESSION> to confirm setting.
- 7) Press <START/STOP> to start and stop timer "A".  
(When timer "A" is up, 4 seconds long beep can be heard. And the timer "A" will directly turn to timer "B". When Timer "B" ends, 4 seconds long beep can also be heard and the timer will switch to timer "A" again. Timer "A" + Timer "B" refer to one complete cycle. This process runs continuously until stop is pressed. The cycle of the Interval Count Down timer repeats to operate with no cycle limit. While the timer is running, the first digit indicates the cycle number which goes from 1>2>3....>0>1>2>3.... as in Figure 13. To distinguish between timer "A" and "B", timer "B" will always keep on blinking.)
- 8) When the Interval Count Down Timer stops, press <MODE> to adjust the timer that will blink momentarily. Press <+/- TEAM 1> and <+/- TEAM 2> to adjust the interval count down timer as before.
- 9) Under any static state, press and hold <SET/POSSESSION> for 3 seconds to reset the time to the original starting time of Timer "A".
- 10) If setting of new interval countdown period value, Press and hold <SET> for 3 seconds twice times to enter the interval count down timer "A" and timer "B" as shown in Figure 11 and Figure 12.
- 11) Under any static state, press and hold <MODE> for 3 seconds to enter the SET POINT MODE.

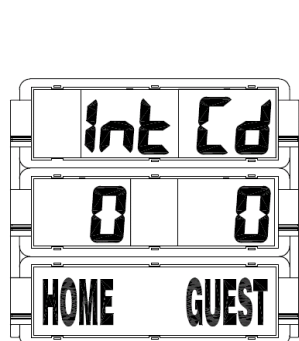

Figure 10

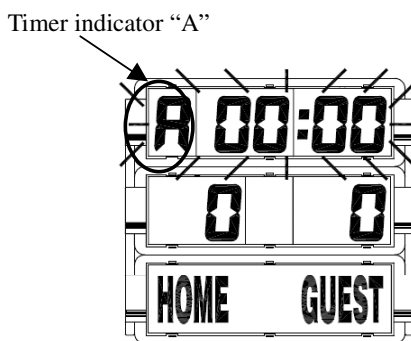

Figure 11

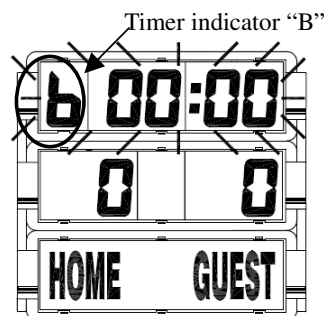

Figure 12

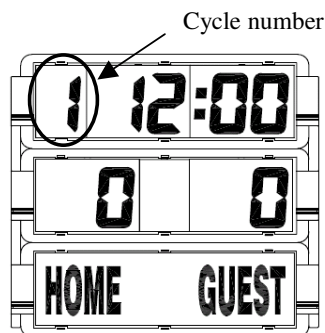

Figure 13

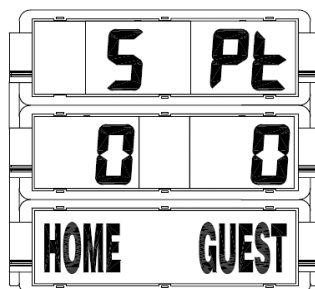

Figure 14

### SET POINT MODE

- 1) In the TIME DISPLAY MODE, press and hold <MODE> 3 seconds 5 times to enter the SET POINT MODE. "S Pt" is shown as in Figure 14.

- 2) Press <SET/POSSESSION> to enter. The period and the possession arrow will blink.
- 3) Press <+/-TEAM2> to enable or disable the period number.
- 4) Press <+/-TEAM1> to enable or disable the possession arrow alternately.
- 5) Press <SET/POSSESSION> to confirm the setting.
- 6) After the above setting, press <SET/POSSESSION> to change the possession arrow direction.
- 7) Press <MODE> to adjust the SET POINT. The 2 teams' set points will blink.
- 8) Press <+/- TEAM 1> to change the set point of TEAM 1, press <+/- TEAM 2> to adjust the set point of TEAM 2.  
(The period will always equal to the sum of two teams' set points plus one. The maximum period can be up to 9.)
- 9) Press <SET/POSSESSION> after setting the SET POINT.
- 10) Under any static state, press and hold <SET/POSSESSION> for 3 seconds to reset the set points of the two teams.
- 11) Under any static state, press and hold <MODE> for 3 seconds to return to the original TIME DISPLAY MODE.

**Remarks:**

If the period is chosen to be blank, the maximum set points of the two teams can be 9:9.

**SCORE**

For resetting the score to zero, press the center of both <+/-TEAM1> and <+/-TEAM2> together for 5 seconds. Scores cannot be adjusted when the screen displays "Hour", "C UP", "C dn", "Int Cd" or "S Pt".

**CARE OF SCOREBOARD:**  
**CHANNEL DESIGNATION**

Each packing box, main Scoreboard and remote control box are labeled with the color codes of one of the four present RF channels (yellow, green, blue and orange). Each set should have the same color code. It is suggested to choose different label set for purchasing 2 to 4 set in order to avoid interference. If more than 4 sets of Scoreboard are used, you can adjust the Scoreboards to different channels by opening the backs of the remote control and the top compartments of the Scoreboard and change the 4 position mini-toggles to different positions. Make sure the 4 position mini-toggles are set to identical ON/OFF positions, else the unit will not work. A maximum of 16 different settings can be achieved.

**WATER RESISTANCE**

The Scoreboard is not water-resistant so it should be kept and used in a dry location. For outdoor use, avoid contact with water or rain.

**TEMPERATURE**

Do not leave the Scoreboard in direct sunlight or under very high temperatures for an extended time, as the display may become black. Do not leave the Scoreboard under very low temperatures, as this may result in slow-moving digits. The above conditions will be corrected when the Scoreboard returns to normal temperatures.

**SHOCKS**

Be careful not to drop the Scoreboard or hit against hard surfaces as it may cause mechanical damages.

**MAGNETISM**

Not affected.

**CHEMICALS**

Do not expose the Scoreboard to solvents such as gasoline, alcohol, cosmetic sprays, cleaners, paints, etc., as they may cause damage to the Scoreboard.

**BATTERY REPLACEMENT (when powered by DC)**

When the display becomes dim or blank, or the remote control does not function, battery replacement is necessary. Replace with alkaline battery size D 1.5V for the scoreboard and alkaline size AAA 1.5V for the remote control. Remove the batteries from the scoreboard and remote control when not being used for an extended time (over 3 months).

**TROUBLESHOOTING**

If the Scoreboard does not function for any reason, contact your dealer for an authorized service center. Do not try to report it yourself.